

DC-ATCO

Direct Current Thermal-Link (Alloy Type)

SF Series



Description

The Direct Current Thermal-Link Alloy Type (DC-ATCO) is defined as a non-resettable protective device functioning one time only. It is widely used in electrical equipment. ATCO is mainly consist of fusible alloy, flux resin, case, sealant and lead wires. Normally, fusible alloy is jointed to the two lead wires. Under abnormal conditions, when the temp. reaches to the fusing temp. of ATCO, the fusible alloy melts and quickly retracts to the two lead wire ends with the aid of the flux resin and disconnects the circuit completely.

SETsafe | SETfuse Direct Current Thermal-Link Alloy Type (DC-ATCO) SF series
 Rated Functioning Temp. from 115 °C to 139 °C, Rated Current: 3 A, 5A, safety certification Includes UL, cUL, and complies with RoHS and REACH.

Features

- Non-Resettable
- High Accuracy of Functioning Temp.
- RoHS & REACH Compliant

Applications

- Lamps
- Switched-Mode Power Supplies
- Home Electrical Appliances
- Transformers
- Motors
- Batteries

Customization

- Other Temp.
- The Length of Lead Wires
- Taping Packing Available
- Lead Wires can be Insulated
- Tinned Copper Wires or CP Wires
- Leads Forming Types

Structure Diagrams

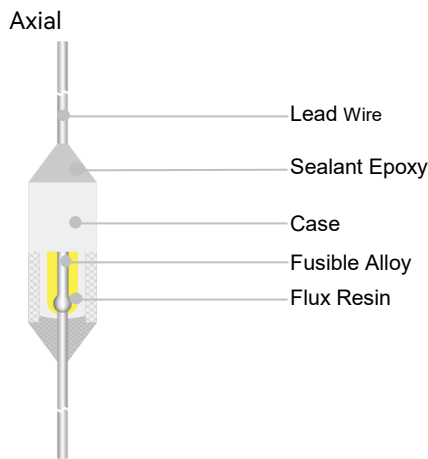

Marking

Axial (Color for reference only)

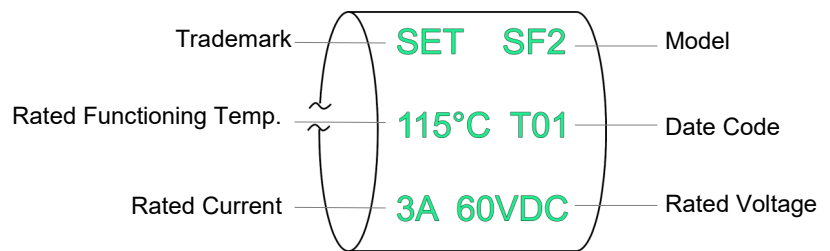

Remark: The first letter of the Date Code Year/quarter A stands for 2000, B stands for 2001, 01 stands for the first quarter, 02 stands for the second quarter, and so on.

Dimensions (mm)

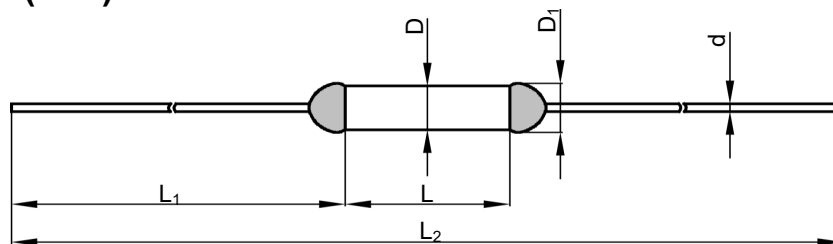

| L | L ₁ | L ₂ | D | D ₁ | d |
|-----------|----------------|----------------|-----------|----------------|-------------|
| 6.0 ± 0.5 | 35.0 ± 2.0 | 76.0 ± 3.0 | 1.5 ± 0.5 | ≤ 2.0 | 0.58 ± 0.05 |



DC-ATCO

Direct Current Thermal-Link (Alloy Type)

SF Series

Specifications

Rated Functioning Temp. (T_f) °C



| | Model | Fusing Temp. | T_h | T_m | I_r | U_r |  |  | RoHS REACH |
|-----|-------|--------------|-------|-------|-------|-------|---|---|---------------|
| | | (°C) | (°C) | (°C) | (A) | (V) | UL | cUL | |
| 139 | SF13 | 135 ± 2 | 85 | 200 | 5 | DC 60 | ● | ● | ● |
| 133 | SF8 | 130 ± 2 | 110 | 200 | 3 | DC 60 | ● | ● | ● |
| 130 | SF4 | 125 ± 2 | 95 | 200 | 3 | DC 60 | ● | ● | ● |
| 115 | SF2 | 111 ± 2 | 90 | 200 | 3 | DC 60 | ● | ● | ● |

Note:

1: "●"Means certificated, "○"Means non-certificated, RoHS & REACH Compliant .

2: " * "Customizable DC voltage.

Agency Information

| Institution | Standards | The File No. and certification No. obtained by SETsafe SETfuse |
|---|----------------|--|
|  | UL 60691 | E214712 |
|  | CAN-CSA-E60691 | E214712 |

Soldering

Hand-Soldering

- Soldering should be carried out according to Table T-1.
- The thermal element of ATCO is fusible alloy with low melting point, which is jointed with ATCO lead wires. Improper soldering operation (too high soldering temp. , too long soldering time, too short lead wire etc.) may transfer more heat to the thermal element and ATCO may open in advance.
- When soldering conditions are more severe than those listed in Table T-1, a heat sink fixture should be used between soldering point and ATCO body.
- When soldering, please do not pull / push or twist ATCO body or lead wires.
- After soldering, let it naturally cool for longer than 20 seconds. During cooling, never move the ATCO body or lead wires.

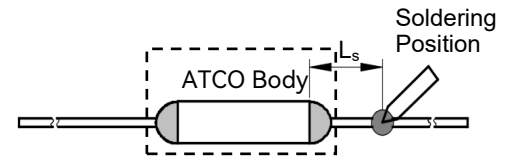

FIGURE T-1

TABLE T-1 Hand-Soldering Time

| Rated Functioning Temp. (T _f) | Max. Allowable Soldering Time for Different Lead Wire Length (Fig.T-1) | | | | | | | | | Max. Soldering Temp. |
|---|--|--------------------|---------|-----------------------|--------------------|---------|-----------------------|--------------------|---------|----------------------|
| | L _s Length | Time | | L _s Length | Time | | L _s Length | Time | | |
| | | Tinned Copper Wire | CP Wire | | Tinned Copper Wire | CP Wire | | Tinned Copper Wire | CP Wire | |
| (°C) | (mm) | (s) | (s) | (mm) | (s) | (s) | (mm) | (s) | (s) | (°C) |
| 115 | 10 | 1 ^a | 4 | 20 | 2 | 5 | 30 | 3 | 6 | 400 |
| 116 to 135 | 10 | 1 ^a | 4 | 20 | 3 | 6 | 30 | 5 | 8 | |
| 136 to 139 | 10 | 3 | 6 | 20 | 5 | 8 | 30 | 5 | 8 | |

Note:

a: Auxiliary Heat Sink Fixture is Required to Avoid ATCO Cutting off Unexpectedly.

DC-ATCO

Direct Current Thermal-Link (Alloy Type)

SF Series

Wave Soldering

The wave soldering parameters as Table T-2, for reference only, when ATCO is for practice use, you need to do some validation experiments. For example, using X-RAY to see the fusible alloy of ATCO whether damage after wave soldering.

TABLE T-2 Wave Soldering Parameters Setting

| Rated Functioning Temp. (T_f) | Max. Allowable Preheating Temp. When the Length of Lead Wire is Different (Fig.T-1) | | | | Preheating Time (t_1) | Max. Wave Soldering Temp. | Dwelling Time (t_2) | Cooling Time (t_3) |
|-----------------------------------|---|------------------|--------------|------------------|---------------------------|---------------------------|-------------------------|------------------------|
| | L_s Length | Preheating Temp. | L_s Length | Preheating Temp. | | | | |
| (°C) | (mm) | (°C) | (mm) | (°C) | (s) | (°C) | (s) | (s) |
| 115 to 130 | Recommend Hand-Soldering | | | | | | | |
| 131 to 139 | 20 | 80 | 30 | 90 | < 60 | ≤ 260 | ≤ 3 | ≤ 10 |

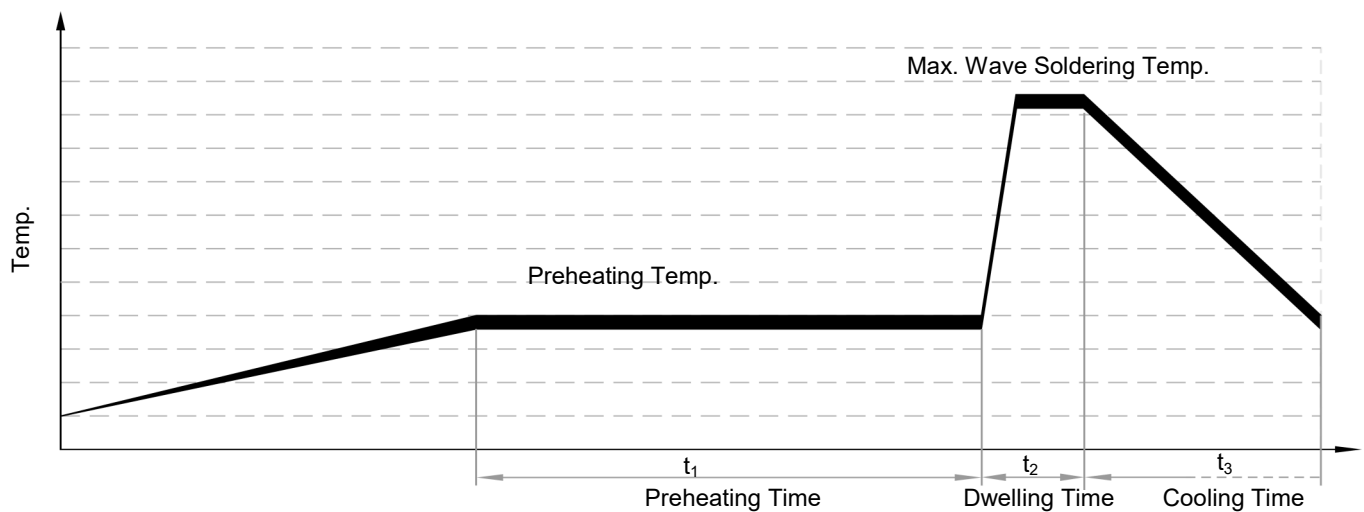

Product Temp.-Time Curve (Reference)

The Temp.-Time Curve of Thermal-Link in different temp. oil bath.

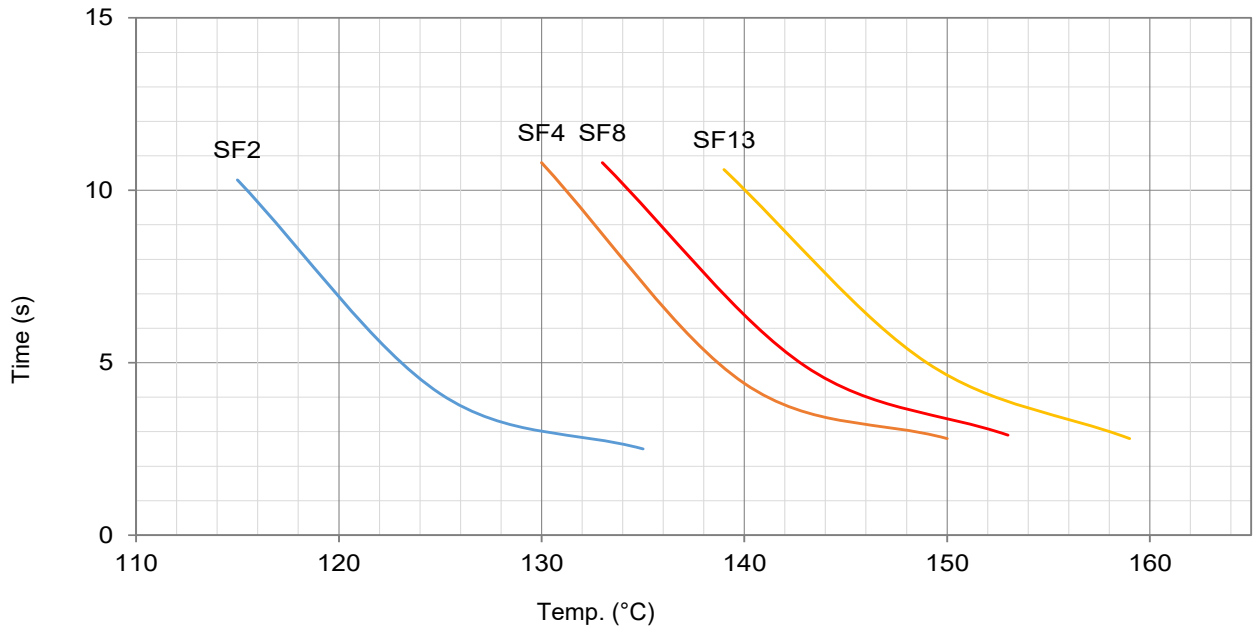

Product Current-Time Curve (Reference)

The Current-Time Curve shows functioning time at multi-times rated current at room temperature $25 \pm 2 \text{ }^\circ\text{C}$.

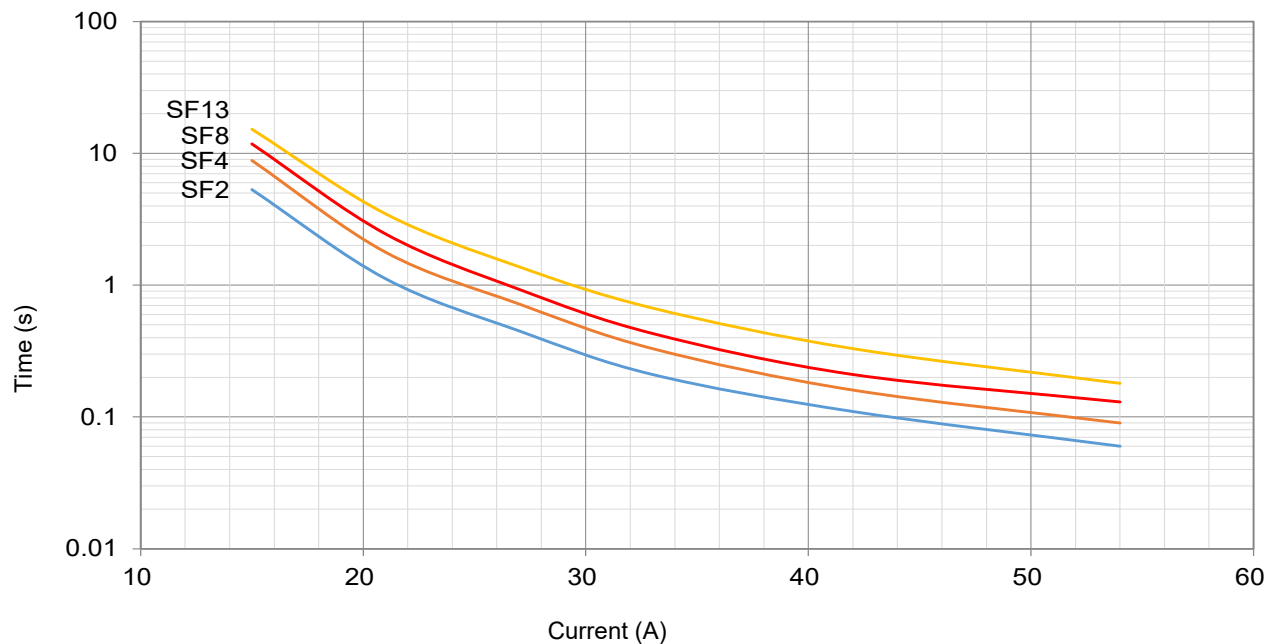

DC-ATCO

Direct Current Thermal-Link (Alloy Type)

SF Series

Packaging Information

Bulk

| Item | PE Bag | PE Bag | Carton |
|-------------------|----------|-----------|-----------------|
| Dimensions (mm) | 135 × 85 | 190 × 180 | 440 × 300 × 260 |
| Quantity (PCS) | 100 | 1000 | 50000 |
| Gross Weight (kg) | | | 11.0 ± 10% |

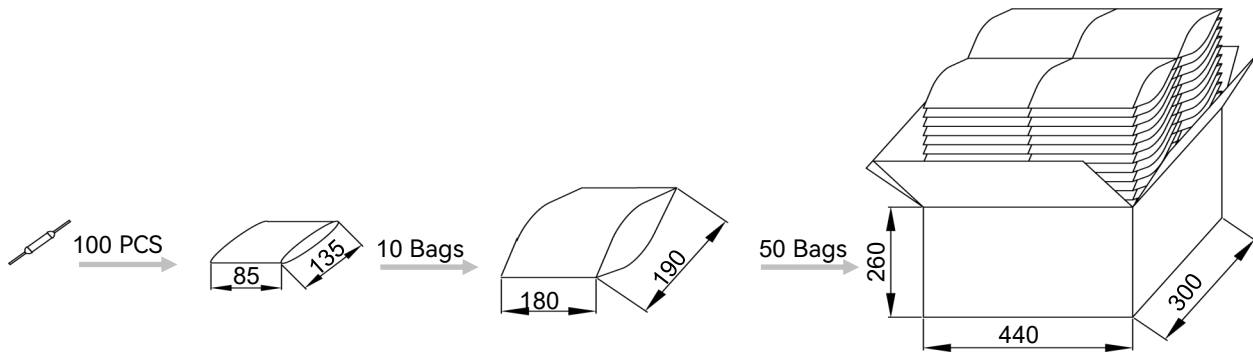

Taping

| Item | Scroll | Box | Carton |
|-------------------|------------|----------------|-----------------|
| Dimensions (mm) | Φ 250 × 94 | 258 × 258 × 98 | 480 × 300 × 260 |
| Quantity (PCS) | 2500 | 2500 | 10000 |
| Gross Weight (kg) | | | 12.0 ± 10% |

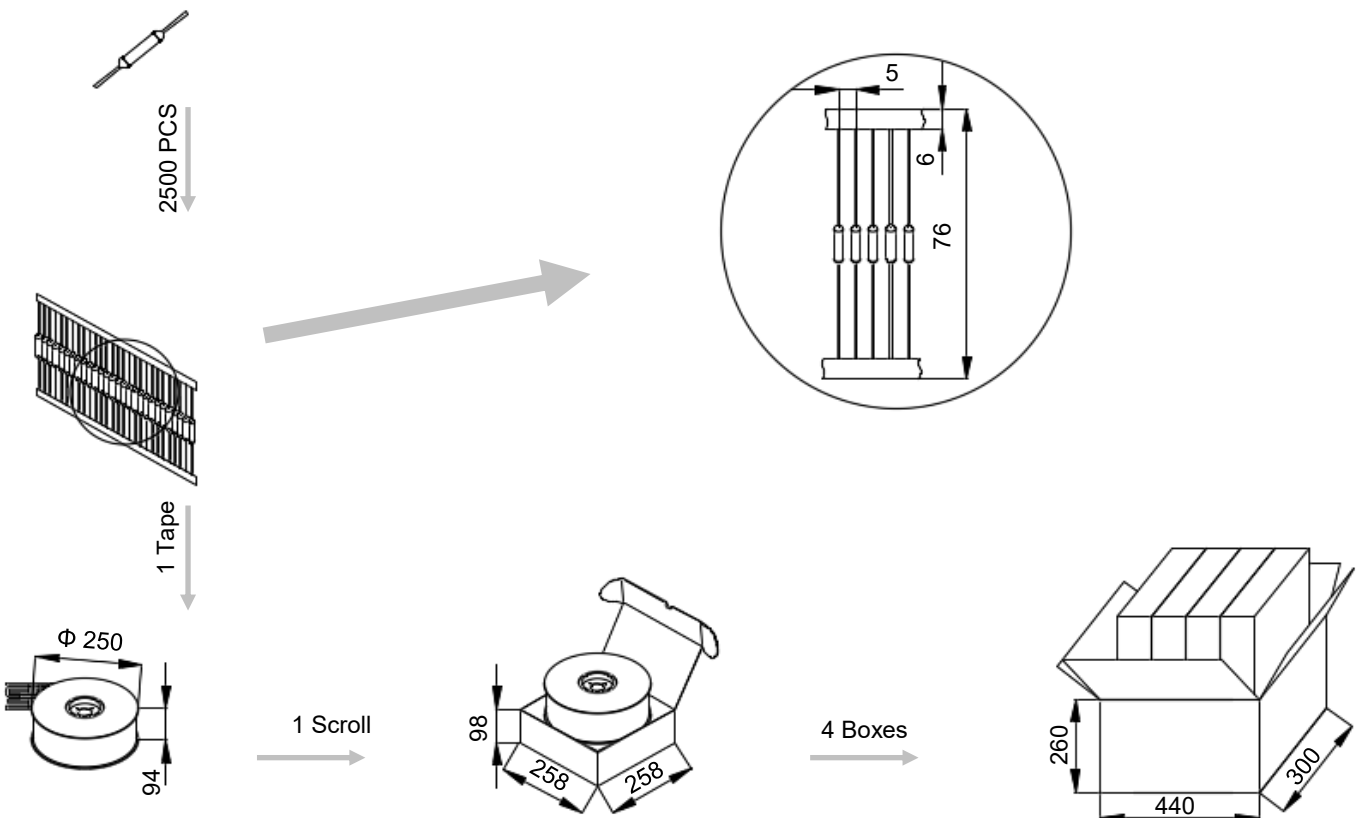

DC-ATCO

Direct Current Thermal-Link (Alloy Type)

SF Series

Part Numbering System

ATCO - SF 2 - A N N A B - 001

Other Options

Packing

B Bulk

T Taping

Leads Forming

A Straight Lead

B Single Lead Bending

C Leads Bending

D Leads Kinking

E Leads Bending and Kinking

Color of Insulation Tube

W White

Y Yellow

R Red

K Black

N None

Insulation Tube Material

T Teflon

P Polyester

N None

Lead Wire Type

A Tinned Copper Wire

B Tinned Copper Plated Wire

Rated Functioning Temp.

2 115 °C, See Specifications

Series

SF Series
See Specifications

Product Category

ATCO Alloy Thermal-Link

Glossary

| Item | Description |
|--------------|--|
| TCO | <p>Thermal-Link A non-resettable device incorporating a THERMAL ELEMENT which will open a circuit once only when exposed for a sufficient length of time to a temperature in excess of that for which it has been designed.</p> <p style="text-align: right;">— (GB 9816.1)</p> |
| ATCO | <p>Alloy Thermal-Link Alloy Type Thermal-Link, Alloy is the thermal element.</p> <p style="text-align: right;">— (GB 9816.1)</p> |
| T_f | <p>Rated Functioning Temp. The temperature of the Alloy Thermal-Link which causes it to change the state of conductivity with a detection current up to 10 mA as the only load.</p> <p style="text-align: right;">— (GB 9816.1)</p> <p>Tolerance: T_f °C (GB 9816.1, EN 60691, K60691). Tolerance: $T_f \pm 7$ °C (J60691).</p> |
| Fusing Temp. | <p>Fusing Temp. The temperature of the Alloy Thermal-Link which causes it to change its state of conductivity is measured with silicone oil bath in which the temperature is increased at the rate of 0.5 °C to 1 °C / minute, with a detection current up to 10 mA as the only load.</p> <p style="text-align: right;">— (GB 9816.1)</p> |
| T_h | <p>Holding Temp. The Maximum temperature at which a Alloy Thermal-Link will not change its state of conductivity when conducting rated current for 168 hours.</p> <p style="text-align: right;">— (GB 9816.1)</p> |
| T_m | <p>Maximum Temp. Limit The temperature of the Alloy Thermal-Link stated by the manufacturer, up to which the mechanical and electrical properties of the Alloy Thermal-Link having changed its state of conductivity, will not be impaired for a given time.</p> <p style="text-align: right;">— (GB 9816.1)</p> |
| I_r | <p>Rated Current The current used to classify a Alloy Thermal-Link, which is the Maximum current that Alloy Thermal-Link allows to carry and is able to cut off the circuit safely.</p> <p style="text-align: right;">— (GB 9816.1)</p> |
| U_r | <p>Rated Voltage The voltage used to classify a Alloy Thermal-Link, which is the Maximum voltage that Alloy Thermal-Link allows to carry and is able to cut off the circuit safely.</p> <p style="text-align: right;">— (GB 9816.1)</p> |
| I_n | <p>Nominal Discharge Current Being able to withstand 15 peak currents of waveform 8/20 μs to test the product's durability of withstanding pulse current.</p> <p style="text-align: right;">— (UL 1449)</p> |
| I_{max} | <p>Max. Discharge Current Being able to withstand 1 peak current of waveform 8/20 μs to test max. pulse current that the product can withstand.</p> <p style="text-align: right;">— (UL 1449)</p> |



ATTENTION

Usage

1. When atmosphere pressure is from 80 kPa to 106 kPa, the related altitude shall be from 2000 meters to - 500 meters.
2. Operating voltage less than rated voltage of ATCO, operating current less than rated current of ATCO.
3. Do not touch the ATCO body or lead wires directly when power is on, to avoid burn or electric shock.

Replace

ATCO is a non-repairable product. For safety sake, it shall be replaced by an equivalent ATCO from the same manufacturer, and mounted in the same way.

Storage

Do not store the ATCO at the high temp., high humidity or corrosive gas environment, avoid influencing the solder-ability of the lead wires, the product shall be used up within 1 year after receiving the goods.

Installation

Make Sure the Temp. of Installation Position.

1. It is recommended that a dummy ATCO with inbuilt thermo-couple shall be used to determine the proper temp.
2. The terminal product should be tested to ensure that potential abnormal conditions do not cause ambient temp. to exceed the T_m of the ATCO.
3. Mount the ATCO at the location where temp. rises evenly.

Installation position of mechanical performance requirements.

1. Do not locate the ATCO in a place where severe vibration always occurs.
2. Ensure that the lead wire is long enough, and avoid actions such as press, tensile or twist.
3. The seal or body of ATCO must not be damaged, burned or over heated.

Mechanical Connection

Riveting

1. Choose small resistivity riveting material and be riveted.
2. A flexible lead or lead with low resistance should be used to rivet the ATCO.
3. Contact resistance should be minimal, large contact resistance will lead to higher temp., ATCO Functioning in advance.

Crimping

1. Choose small resistivity crimping material and be crimped.
2. A flexible lead or lead with low resistance should be used to rivet the ATCO.
3. Contact resistance should be minimal, large contact resistance will lead to higher Temp., ATCO Functioning in advance.

Lead Wire Forming

1. If lead wire has to be bent, please pay attention to the distance between body and bending point. Refer to Table T-3.
2. When bending leads, please use pincher or similar tools to fix the product as shown in Fig.T-2, to avoid damaging the product.
3. During forming and mounting, lead wire should not be cut, nicked, bent sharply, to avoid breaking the product.
4. Tangential forces on the leads must be avoided (i.e. pushing or pulling on the leads at angle to ATCO body) as such forces may damage the seal of ATCO.

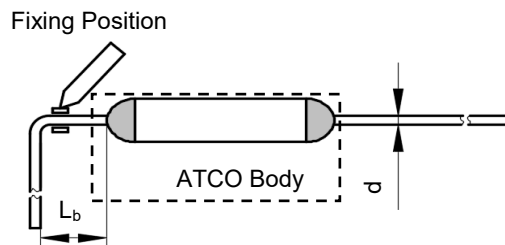

FIGURE T-2

TABLE T-3 Distance between Body and Bending Point

| Circular lead | d | (mm) | < 1.0 | 1.0 - 1.2 | > 1.2 |
|---------------|----------------|------|-------|-----------|-------|
| | L _b | (mm) | ≥ 3 | ≥ 5 | ≥ 10 |







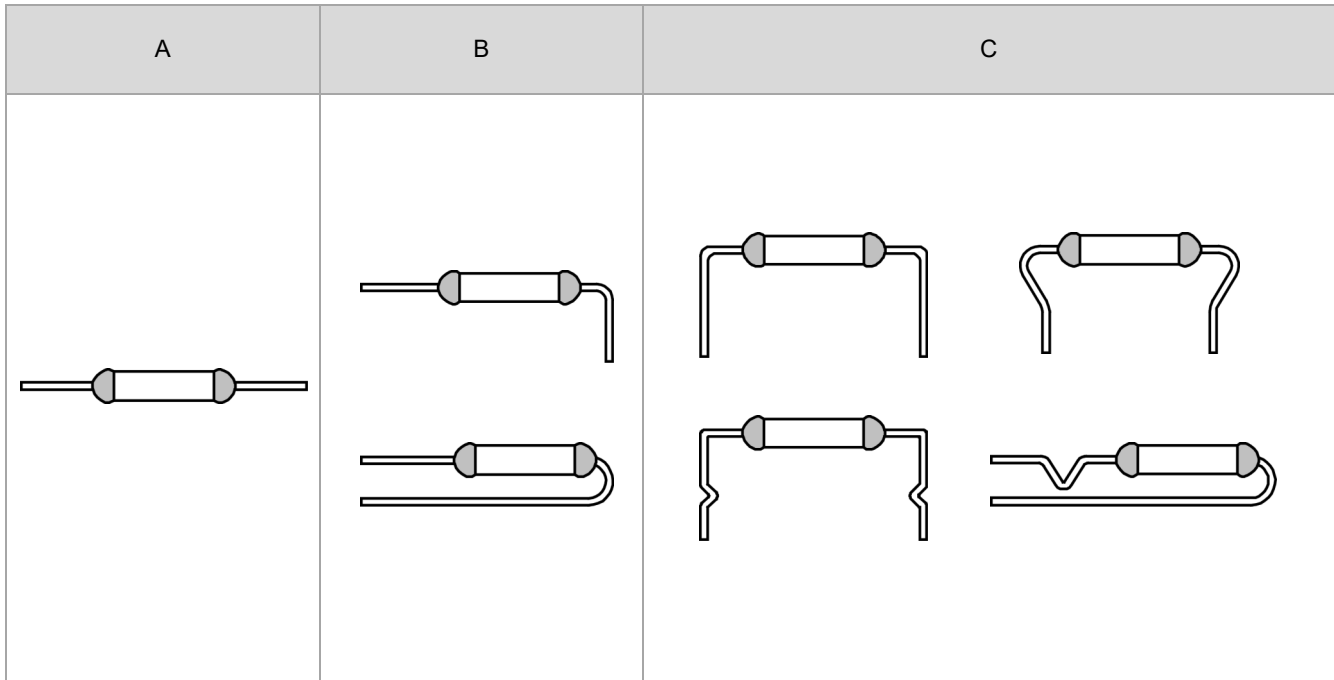

Leads Forming Types

The below leads forming is for reference, more leads forming can be customized.



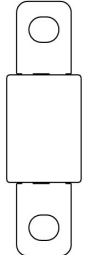
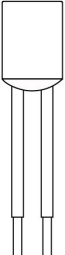

Axial

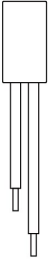

Direct Current Thermal-Link Alloy Type (DC-ATCO) Features & Model List Overview

| Rated Functioning Temp. (T _r) °C | Model | | | | | | | | |
|---|---|---|---|---|---|---|---|---|---|
| | TGH187-HVS [^] | ASL187A-LSF [^] | RSK187A-KSS [^] | RVH187-HSF [^] | ARL187-LRA [^] | | | RQF187-FQS [^] | |
| 230 | ○ | ○ | ○ | ○ | ○ | ○ | ○ | ○ | ○ |
| 221 | ○ | ○ | ○ | ○ | ○ | ○ | ○ | ○ | ○ |
| 205 | ○ | ○ | ○ | ○ | ○ | ○ | ○ | ○ | ○ |
| 200 | ○ | ○ | ○ | ○ | ○ | ○ | ○ | ○ | ○ |
| 187 | TGH187-HVS [^] | ASL187A-LSF [^] | RSK187A-KSS [^] | RVH187-HSF [^] | ARL187-LRA [^] | ○ | ○ | RQF187-FQS [^] | ○ |
| 160 | ○ | ○ | ○ | ○ | ○ | ○ | ○ | ○ | ○ |
| 150 | TGH150-HVS [^] | ASL150A-LSF [^] | RSK150A-KSS [^] | RVH150-HSF [^] | ARL150-LRA [^] | RPK150-HRZ [^] | TG150C-HQZ [^] | RQF150-FQS [^] | TG150C-JPZ [^] |
| 145 | ○ | ○ | ○ | ○ | ○ | ○ | ○ | ○ | ○ |
| 139 | ○ | ○ | ○ | ○ | ○ | ○ | ○ | ○ | ○ |
| 136 | TGH136-HVS [^] | ASL136A-LSF [^] | RSK136A-KSS [^] | RVH136-HSF [^] | ARL136-LRA [^] | RPK136-HRZ [^] | TG136C-HQZ [^] | RQF136-FQS [^] | TG136C-JPZ [^] |
| 135 | ○ | ○ | ○ | ○ | ○ | ○ | ○ | ○ | ○ |
| 133 | ○ | ○ | ○ | ○ | ○ | ○ | ○ | ○ | ○ |
| 130 | TGH130-HVS [^] | ○ | ○ | RVH130-HSF [^] | ○ | ○ | ○ | RQF130-FQS [^] | ○ |
| 125 | TGH125-HVS [^] | ASL125A-LSF [^] | RSK125A-KSS [^] | RVH125-HSF [^] | ARL125-LRA [^] | RPK125-HRZ [^] | TG125C-HQZ [^] | RQF125-FQS [^] | TG125C-JPZ [^] |
| 123 | ○ | ○ | ○ | ○ | ○ | ○ | ○ | ○ | ○ |
| 120 | ○ | ○ | ○ | ○ | ○ | ○ | ○ | ○ | ○ |
| 115 | TGH115-HVS [^] | ASL115A-LSF [^] | RSK115A-KSS [^] | RVH115-HSF [^] | ARL115-LRA [^] | RPK115-HRZ [^] | TG115C-HQZ [^] | RQF115-FQS [^] | TG115C-JPZ [^] |
| 105 | ○ | ○ | ○ | ○ | ○ | ○ | ○ | ○ | ○ |
| 102 | TGH102-HVS [^] | ASL102A-LSF [^] | RSK102A-KSS [^] | RVH102-HSF [^] | ARL102-LRA [^] | RPK102-HRZ [^] | TG102C-HQZ [^] | RQF102-FQS [^] | TG102C-JPZ [^] |
| 97 | ○ | ○ | ○ | ○ | ○ | ○ | ○ | ○ | ○ |
| 93 | ○ | ○ | ○ | ○ | ○ | ○ | ○ | ○ | ○ |
| 86 | ○ | ○ | ○ | ○ | ARL86-LRA [^] | ○ | TG86C-HQZ [^] | RQF86-FQS [^] | ○ |
| 76 | ○ | ○ | ○ | ○ | ○ | ○ | ○ | ○ | ○ |
| I_r (A) Rated Current | 15 | 30 | 25 | 15 | 30 | 15 | 15 | 10 | 20 |
| U_r (VDC)[^] Rated Voltage | 850 | | 600 | | 500 | | 450 | | 400 |
| U_r (VAC)[*] Rated Voltage | ○ | ○ | ○ | ○ | ○ | ○ | ○ | ○ | ○ |
| Product Structure |  |  |  |  |  |  |  |  |  |
| | Axial Shape | | Radial Shape | | Axial Shape | Radial Shape | Axial Shape | Radial Shape | Axial Shape |

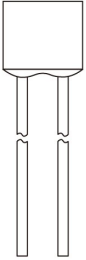

Direct Current Thermal-Link Alloy Type (DC-ATCO) Features & Model List Overview

| Rated Functioning Temp. (T_r) °C | Model | | | | | | | | | | | |
|--------------------------------------|---|---|---|---|---|---|---------|--------------|---------|----------|---------|---------|
| | TG150C-JSZ* | | | | HN150^* | HP150^* | HS150^* | | QD150^A | PD150^A | TD150^A | SD150^A |
| 230 | ○ | ○ | ○ | ○ | ○ | ○ | ○ | ○ | ○ | ○ | ○ | ○ |
| 221 | ○ | ○ | ○ | ○ | ○ | ○ | ○ | ○ | ○ | ○ | ○ | ○ |
| 205 | ○ | ○ | ○ | ○ | ○ | ○ | ○ | ○ | ○ | ○ | ○ | ○ |
| 200 | ○ | ○ | ○ | ○ | ○ | ○ | ○ | ○ | ○ | ○ | ○ | ○ |
| 187 | ○ | ○ | ○ | ○ | ○ | ○ | ○ | ○ | ○ | ○ | ○ | ○ |
| 160 | ○ | ○ | ○ | ○ | ○ | ○ | ○ | ○ | ○ | ○ | ○ | ○ |
| 150 | TG150C-JSZ* | ○ | ○ | ○ | HN150^* | HP150^* | HS150^* | ○ | QD150^A | PD150^A | TD150^A | SD150^A |
| 145 | ○ | ○ | ○ | ○ | ○ | ○ | ○ | ○ | ○ | ○ | ○ | ○ |
| 139 | ○ | ○ | ○ | ○ | ○ | ○ | ○ | ○ | ○ | ○ | ○ | ○ |
| 136 | TG136C-JSZ* | ○ | ○ | ○ | HN136^* | HP136^* | HS136^* | ○ | QD136^A | PD136^A | TD136^A | SD136^A |
| 135 | ○ | ○ | ○ | ○ | ○ | ○ | ○ | ○ | ○ | ○ | ○ | ○ |
| 133 | ○ | ○ | ○ | ○ | ○ | ○ | ○ | ○ | ○ | ○ | ○ | ○ |
| 130 | ○ | ○ | ○ | ○ | ○ | ○ | ○ | ○ | QD130^A | PD130^A | TD130^A | SD130^A |
| 125 | TG125C-JSZ* | ○ | ○ | ○ | HN125^* | HP125^* | HS125^* | ALP125-PLZ^A | QD125^A | PD125^A | TD125^A | SD125^A |
| 123 | ○ | ○ | ○ | ○ | ○ | ○ | ○ | ○ | ○ | ○ | ○ | ○ |
| 120 | ○ | ○ | ○ | ○ | ○ | ○ | ○ | ○ | ○ | ○ | ○ | ○ |
| 115 | TG115C-JSZ* | ○ | ○ | ALP115-HLZ^A | ○ | ○ | ○ | ○ | QD115^A | PD115^A | TD115^A | SD115^A |
| 105 | ○ | ○ | ○ | ○ | ○ | ○ | ○ | ○ | ○ | ○ | ○ | ○ |
| 102 | TG102C-JSZ* | ○ | ○ | ○ | ○ | ○ | ○ | ALP102-PLZ^A | QD102^A | PD102^A | TD102^A | SD102^A |
| 97 | ○ | ○ | ○ | ○ | ○ | ○ | ○ | ○ | ○ | ○ | ○ | ○ |
| 93 | ○ | ○ | ○ | ○ | ○ | ○ | ○ | ○ | ○ | ○ | ○ | ○ |
| 86 | ○ | TG86C-HSZ* | RPF86-FPF^A | ○ | ○ | ○ | ○ | ○ | ○ | ○ | ○ | ○ |
| 76 | ○ | ○ | ○ | ○ | ○ | ○ | ○ | ○ | ○ | ○ | ○ | ○ |
| I_r (A) Rated Current | 20 | 15 | 10 | 15 | 15 | 10 | 5 | 60 | 20 | 15 16 | 10 | 25 |
| U_r (VDC)^A Rated Voltage | ○ | 400 | 200 | 180 | 125 | | | | | | | |
| U_r (VAC)^* Rated Voltage | 600 | ○ | 690 | 500 | ○ | | | | | | | |
| Product Structure |  |  |  |  |  |  | | | | | | |
| | Axial Shape | Radial Shape | | Axial Shape | | Radial Shape | | | | | | |

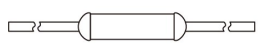
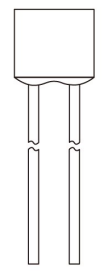
Direct Current Thermal-Link Alloy Type (DC-ATCO) Features & Model List Overview

| Rated Functioning Temp. (T_f) °C | Model | | | | | | | | | | | | | | | | | | | | | |
|--------------------------------------|-------|---|-------|------|-------|-------|------|-------|-----|--------|-------|---|-------|-------|-------|-------|-------|------|-------|-------|-------|-------|
| | R31^* | U31^* | | | | | | C31^* | | | | | B31^* | H31^* | V31^* | V31^* | | | X31^* | K31^* | | |
| 230 | ○ | ○ | ○ | ○ | ○ | ○ | ○ | ○ | ○ | ○ | ○ | ○ | ○ | ○ | ○ | ○ | ○ | ○ | ○ | ○ | ○ | ○ |
| 221 | R32^* | ○ | U32^* | ○ | ○ | ○ | ○ | ○ | ○ | ○ | ○ | ○ | B32^* | ○ | H32^* | V32^* | V32^* | ○ | ○ | X32^* | K32^* | ○ |
| 205 | ○ | ○ | ○ | ○ | ○ | ○ | ○ | ○ | ○ | ○ | ○ | ○ | ○ | ○ | ○ | ○ | ○ | ○ | ○ | ○ | ○ | ○ |
| 200 | ○ | ○ | ○ | ○ | ○ | ○ | ○ | ○ | ○ | ○ | ○ | ○ | ○ | ○ | ○ | ○ | ○ | ○ | ○ | ○ | ○ | ○ |
| 187 | ○ | ○ | ○ | ○ | ○ | ○ | ○ | ○ | ○ | ○ | ○ | ○ | ○ | ○ | ○ | ○ | ○ | ○ | ○ | X17^* | K17^* | ○ |
| 160 | R16^* | ○ | U16^* | ○ | ○ | ○ | ○ | ○ | ○ | ○ | ○ | ○ | ○ | ○ | H16^* | V16^* | ○ | ○ | ○ | X16^* | K16^* | F16^* |
| 150 | R7^* | ○ | U7^* | ○ | ○ | ○ | ○ | ○ | ○ | ○ | ○ | ○ | ○ | ○ | ○ | ○ | ○ | ○ | ○ | X7^* | K7^* | F7^* |
| 145 | R6^* | ○ | U6^* | C6^* | ○ | ○ | ○ | ○ | ○ | ○ | ○ | ○ | ○ | ○ | ○ | ○ | ○ | K6^* | F6^* | X6^* | K6^* | F6^* |
| 139 | ○ | CR13^* | ○ | ○ | M13^* | C13^* | ○ | ○ | ○ | SF13^* | V13^* | ○ | ○ | ○ | ○ | ○ | ○ | ○ | F13^* | ○ | ○ | F13^* |
| 136 | ○ | ○ | ○ | ○ | ○ | ○ | ○ | ○ | ○ | ○ | ○ | ○ | ○ | ○ | ○ | ○ | ○ | K9^* | ○ | X9^* | K9^* | ○ |
| 135 | R5^* | ○ | U5^* | ○ | ○ | ○ | ○ | ○ | ○ | ○ | ○ | ○ | ○ | ○ | ○ | ○ | ○ | ○ | ○ | X5^* | K5^* | ○ |
| 133 | ○ | ○ | ○ | ○ | ○ | ○ | ○ | ○ | ○ | ○ | V8^* | SF8^* | ○ | ○ | ○ | ○ | ○ | ○ | F8^* | X8^* | K8^* | F8^* |
| 130 | R4^* | ○ | U4^* | ○ | ○ | ○ | ○ | ○ | ○ | ○ | V4^* | SF4^* | ○ | ○ | ○ | ○ | ○ | ○ | F4^* | X4^* | K4^* | F4^* |
| 125 | R3^* | ○ | U3^* | ○ | ○ | ○ | ○ | ○ | ○ | ○ | ○ | ○ | ○ | ○ | H3^* | ○ | ○ | ○ | ○ | X3^* | K3^* | F3^* |
| 123 | ○ | ○ | ○ | ○ | ○ | ○ | ○ | ○ | ○ | ○ | ○ | ○ | ○ | ○ | ○ | ○ | ○ | ○ | ○ | ○ | ○ | ○ |
| 120 | ○ | ○ | ○ | ○ | ○ | ○ | ○ | ○ | ○ | ○ | ○ | ○ | ○ | ○ | ○ | ○ | ○ | ○ | ○ | ○ | ○ | ○ |
| 115 | R2^* | ○ | U2^* | ○ | ○ | ○ | C2^* | ○ | ○ | ○ | V2^* | SF2^* | ○ | ○ | ○ | ○ | ○ | ○ | F2^* | X2^* | K2^* | F2^* |
| 105 | ○ | ○ | ○ | ○ | ○ | ○ | ○ | ○ | ○ | ○ | ○ | ○ | ○ | ○ | ○ | ○ | ○ | ○ | ○ | ○ | ○ | ○ |
| 102 | R1^* | ○ | U1^* | ○ | ○ | ○ | ○ | ○ | ○ | ○ | ○ | ○ | ○ | ○ | ○ | ○ | ○ | ○ | F1^* | X1^* | K1^* | F1^* |
| 97 | ○ | ○ | ○ | ○ | ○ | ○ | ○ | ○ | ○ | ○ | ○ | ○ | ○ | ○ | ○ | ○ | ○ | ○ | ○ | ○ | ○ | ○ |
| 93 | ○ | ○ | ○ | ○ | ○ | ○ | ○ | ○ | ○ | ○ | ○ | ○ | ○ | ○ | ○ | ○ | ○ | ○ | ○ | ○ | ○ | ○ |
| 86 | R18^* | ○ | U18^* | ○ | ○ | ○ | ○ | C18^* | ○ | ○ | ○ | ○ | ○ | ○ | V18^* | ○ | ○ | ○ | F18^* | X18^* | K18^* | F18^* |
| 76 | R0^* | ○ | U0^* | ○ | ○ | ○ | ○ | ○ | ○ | ○ | ○ | ○ | ○ | ○ | ○ | ○ | ○ | ○ | ○ | X0^* | K0^* | F0^* |
| I_r (A) Rated Current | | 15 | 10 | 9 | 8.5 | 8 | 6 | 5 | 4 | 3 | 2.5 | 2 | 1 | 4 | 3 | 2 | 1 | | | | | |
| U_r (VDC)^* Rated Voltage | | 60 | | | | | | | | | | | | | | | | | | | | |
| U_r (VAC)^* Rated Voltage | | 250 | ○ | 250 | ○ | 250 | | ○ | 250 | | ○ | 250 | 125 | ○ | 250 | | | | | | | |
| Product Structure | |  Axial Shape | | | | | | | | | |  Radial Shape | | | | | | | | | | |

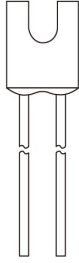
Direct Current Thermal-Link Alloy Type (DC-ATCO) Features & Model List Overview

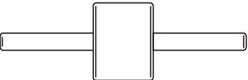
| Rated Functioning Temp. (T _r) °C | Model | | | | | | | | | | Model | | | | |
|---|---|---------------------|------------------|--------------------|--|--------------------|--------------------|--------------------|--------------------|--------------------|---|--------------------------|--------------------------|--------------------------|--|
| | XG31* | KG31* | | | C31* | | B31* | | H31* | | ADN230B-NDZ ^Δ | ADN230B-PDZ ^Δ | | ADN230B-QBZ ^Δ | |
| 230 | ○ | ○ | ○ | ○ | ○ | ○ | ○ | ○ | ○ | ○ | ○ | ○ | ○ | ○ | |
| 221 | XG31* | KG31* | ○ | ○ | C31* | ○ | B31* | ○ | H31* | ○ | ○ | ○ | ADN205B-NDZ ^Δ | ○ | |
| 205 | XG32* | KG32* | ○ | ○ | C33* | ○ | B32* | ○ | H32* | ○ | ○ | ○ | ○ | ○ | |
| 200 | ○ | ○ | ○ | ○ | ○ | ○ | ○ | ○ | ○ | ○ | ○ | ○ | ○ | ○ | |
| 187 | ○ | ○ | ○ | ○ | ○ | ○ | ○ | ○ | ○ | ○ | ○ | ○ | ○ | ○ | |
| 160 | XG16* | KG16* | ○ | ○ | ○ | B16* | ○ | ○ | ○ | ○ | ○ | ○ | ○ | ○ | |
| 150 | XG7* | KG7* | C7 ^Δ | C7* | ○ | B7 ^Δ | ○ | H7 ^Δ | ○ | V7 ^Δ | ○ | ○ | ○ | ○ | |
| 145 | XG6* | KG6* | C6 ^Δ | C6* | ○ | B6 ^Δ | ○ | H6 ^Δ | ○ | V6 ^Δ | ○ | ○ | ○ | ○ | |
| 139 | ○ | ○ | C13 ^Δ | C13* | ○ | B13 ^Δ | ○ | H13 ^Δ | ○ | V13 ^Δ | ○ | ○ | ○ | ○ | |
| 136 | XG9* | KG9* | C9 ^Δ | C9* | ○ | B9 ^Δ | ○ | H9 ^Δ | ○ | V9 ^Δ | ○ | ○ | ○ | ○ | |
| 135 | XG5* | KG5* | C5 ^Δ | C5* | ○ | B5 ^Δ | ○ | H5 ^Δ | ○ | V5 ^Δ | ○ | ○ | ○ | ○ | |
| 133 | XG8* | KG8* | C8 ^Δ | C8* | ○ | B8 ^Δ | ○ | H8 ^Δ | ○ | V8 ^Δ | ○ | ○ | ○ | ○ | |
| 130 | XG4* | KG4* | C4 ^Δ | C4* | ○ | B4 ^Δ | ○ | H4 ^Δ | ○ | V4 ^Δ | ○ | ○ | ○ | ○ | |
| 125 | XG3 ^Δ * | KG3 ^Δ * | C3 ^Δ | C3* | ○ | B3 ^Δ * | ○ | ○ | ○ | V3 ^Δ * | ○ | ○ | ○ | ○ | |
| 123 | ○ | ○ | ○ | ○ | ○ | ○ | ○ | ○ | ○ | ○ | ○ | ○ | ○ | ○ | |
| 120 | ○ | ○ | ○ | ○ | ○ | ○ | ○ | ○ | ○ | ○ | ○ | ○ | ○ | ○ | |
| 115 | XG2 ^Δ * | KG2 ^Δ * | C2 ^Δ | C2* | ○ | B2 ^Δ * | ○ | H2 ^Δ * | ○ | V2 ^Δ * | ○ | ○ | ○ | ○ | |
| 105 | ○ | ○ | ○ | ○ | ○ | ○ | ○ | ○ | ○ | ○ | ○ | ○ | ○ | ○ | |
| 102 | XG1 ^Δ * | KG1 ^Δ * | ○ | C1 ^Δ * | C1* | B1* | B1* | H1* | H1* | V1* | V1* | ○ | ○ | ○ | |
| 97 | ○ | ○ | ○ | ○ | C21 ^Δ * | ○ | B21 ^Δ * | ○ | H21 ^Δ * | ○ | V21 ^Δ * | ○ | ○ | ○ | |
| 93 | ○ | ○ | ○ | ○ | ○ | ○ | ○ | ○ | ○ | ○ | ○ | ○ | ○ | ○ | |
| 86 | XG18 ^Δ * | KG18 ^Δ * | ○ | C18 ^Δ * | C18* | B18 ^Δ * | B18* | H18 ^Δ * | H18* | V18 ^Δ * | V18* | ○ | ○ | ○ | |
| 76 | XG0* | KG0* | ○ | C0* | ○ | B0 ^Δ * | B0* | H0 ^Δ * | H0* | V0 ^Δ * | V0* | ○ | ○ | ○ | |
| I_r (A) Rated Current | 3 | 2 | 7 | 5 | 3 | 2 | 1 | 50 | 55 | 50 | 80 | | | | |
| U_r (VDC)^Δ Rated Voltage | 60 | | 50 | | | | | | | | 49 | 48 | 24 | | |
| U_r (VAC)[*] Rated Voltage | 250 | | ○ | 250 | 125 | 250 | 125 | 250 | 125 | 250 | 125 | ○ | | | |
| Product Structure |  <p>Radial Shape</p> | | | |  <p>Axial Shape</p> | | | | | |  | | | | |